

**B.E.G.****LUXOMAT®**

## LC-Click-N 200

Prod.No. 91002 EAN: 4007529910021

- Voltage: 110 - 240 V AC 50 / 60 Hz
- Dimensions: 103 x 78 x 80 mm
- Power consumption: approx. 0.4 W

### Areas of application

- outdoor areas (entrances/access roads)
- parking areas
- underground car parks

### Order data

Designation	Colour	Art.No
LC-Click-N 200	white	91002

### Accessories

Designation	Colour	Art.No
Wire basket BSK (Ø 164 x 143 mm)	white	92467
RC-Arc extinction kit	white	10880
Mini-RC-Arc extinction kit		10882

## Technical data

Voltage:	110 - 240 V AC 50 / 60 Hz
Dimensions:	103 x 78 x 80 mm
Power consumption:	approx. 0.4 W
Detection area:	horizontal 200° (Wall mounting) max. 12 m across max. 4 m towards
Range:	max. 2 m anti- creep protection
Monitored area (tangential movement):	250 m <sup>2</sup> / 2.5 m mounting height
Mounting height min./max./recommended:	2 m / 3 m / 2.5 m
Degree / class of protection:	IP54 / Class II
Impact strength:	IK04
Ambient temperature:	-25 °C to +50 °C
Housing:	polycarbonate, UV-resistant
Material color:	white mat, similar to RAL9010

### Channel 1 (lighting control)

	1000 W, $\cos \varphi$ = 1
Switching power:	500 VA, $\cos \varphi$ = 0.5 200 W LED
Type of contact (k):	1x $\mu$ -contact, NO contact
Follow-up time:	4 sec - 20 min
Switch-on threshold:	2 - 500 Lux

## Product information

Motion detector with 200° detection area and 180° anti-creep zone

Adjustable ball head

Detection area can be restricted with blinds

Zero crossing switching

Simple mounting thanks to plug base

Cable entry possible from above, from below and from behind

Can be mounted on standard flush-mount boxes

### Application examples:

outdoor areas (entrances/access roads), parking areas,  
underground car parks

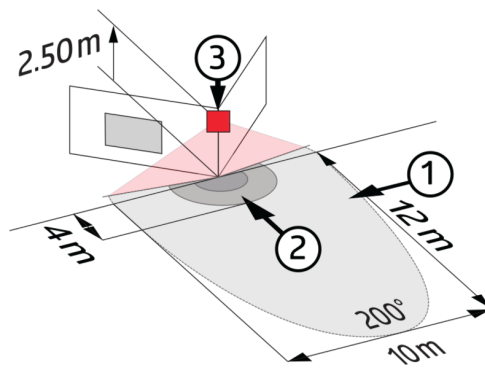
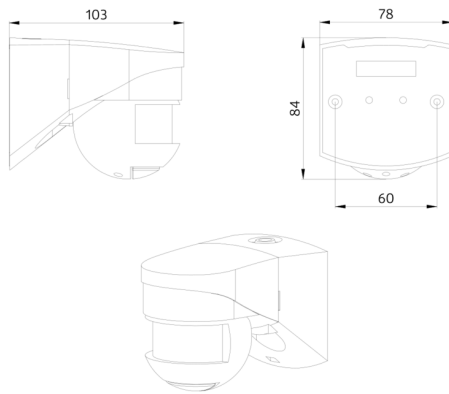

## Accessories



### Wire basket BSK (Ø 164 x 143 mm)

Art.No: 92467

Dimensions: Ø 164 x 143 mm  
Impact strength: IK09  
Housing: coated steel basket



### RC-Arc extinction kit

Art.No: 10880

Voltage: 230 V AC  $\pm 10\%$   
Dimensions: 38 x 12 x 26 mm  
Degree / class of protection: IP20 / Class II



### Mini-RC-Arc extinction kit

Art.No: 10882

Voltage: 230 V AC  $\pm 10\%$   
Dimensions: 50 x 23 x 8 mm  
Degree / class of protection: IP20 / Class II